

ENERGY STORAGE SYSTEM

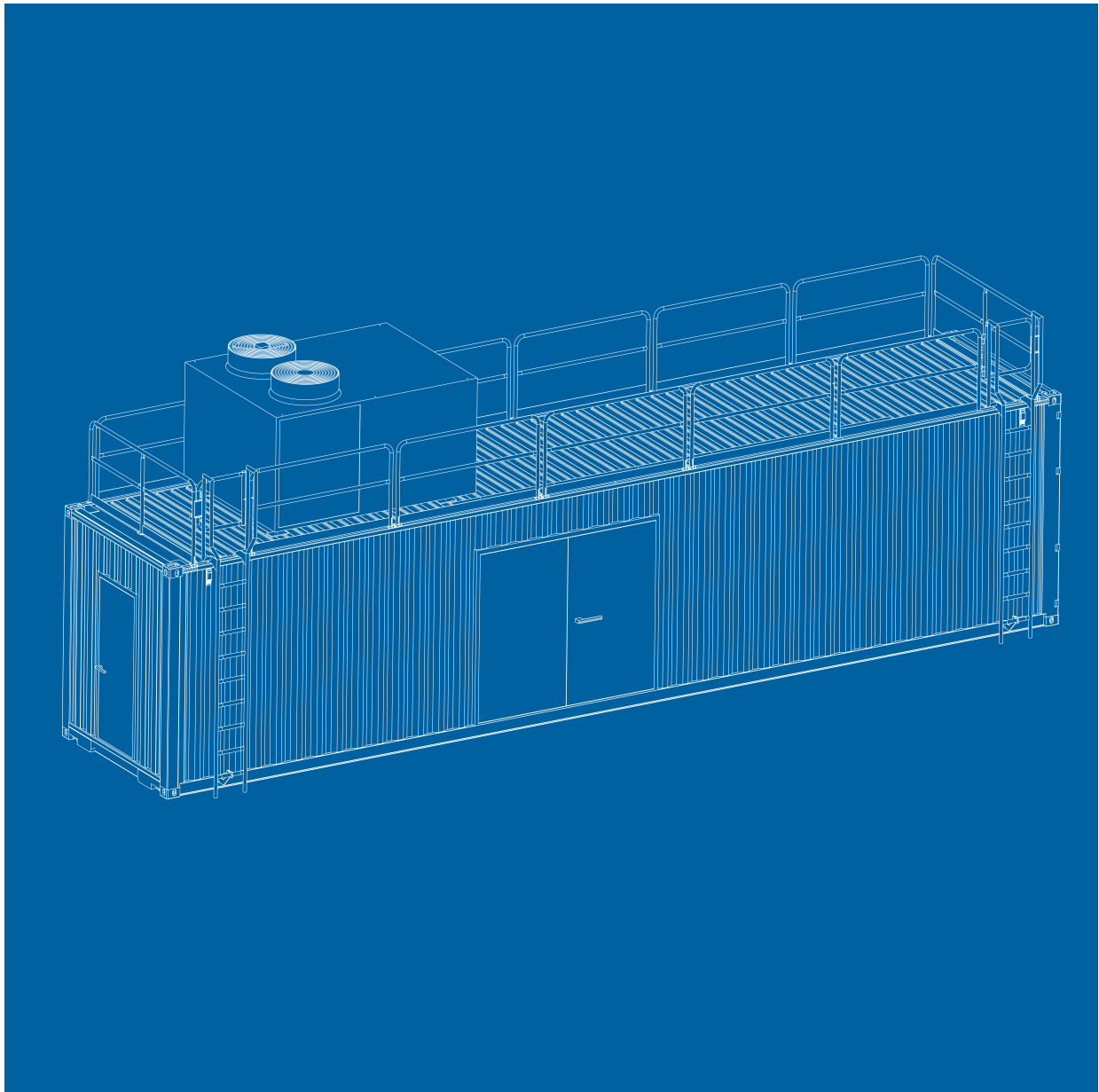

MERUS ESS

Energy Storage Systems from utility scale applications to island mode micro grids.



MERUS ENERGY STORAGE SYSTEM

FOR APPLICATIONS IN RENEWABLES, T&D, ISLAND, HYBRID & MICROGRID

Merus ESS systems can be placed at any level of an electrical system to increase operational performance and reliability. Not only do they enable smoother integration of renewable energy sources, but they also help balance electricity supply and demand. With Merus ESS, energy is available in

real time when primary power sources have been interrupted. The solution provides benefits for the entire power system, from generation, transmission and distribution to micro grid operators, all the way to end consumers.



GENERATION - WIND, SOLAR AND ENGINE-HYBRID POWER PLANTS

- **Peak shaving**
- **Ramp rate management**
- **Energy shifting**
- **Power dispatch management**

INTEGRATED MERUS ESS

**EASE OF INTEGRATION OF RENEWABLES WITH MODULAR DESIGN
AND IMPROVED POWER QUALITY**

The Merus ESS, built on state-of-the-art technology, is a fully scalable modular solution, in terms of output power and energy, for any voltage level of the grid. The latest high efficiency bidirectional converter technology together with continuously developing storage media, selected specifically for the customer's needs, ensure efficiency and a long lifetime of the storage solution. Merus MCC - control, protection, monitoring and SCADA system manage the entire storage, along with energy management and optimization of renewables and all communication with higher level operators.



TRANSMISSION AND DISTRIBUTION GRIDS

- Spinning reserve
- Frequency regulation
- Power flow optimization
- System stability improvement
- Voltage control



INDUSTRIAL AND NATURAL ISLAND GRIDS, MICROGRIDS AND HYBRID SYSTEMS

- Energy management for alternative sources including solar, wind and fossil fuel power plants
- Black start functionality
- Peak shaving
- Power quality compliance
- Voltage and frequency control



MERUS ESS BUILDING BLOCKS

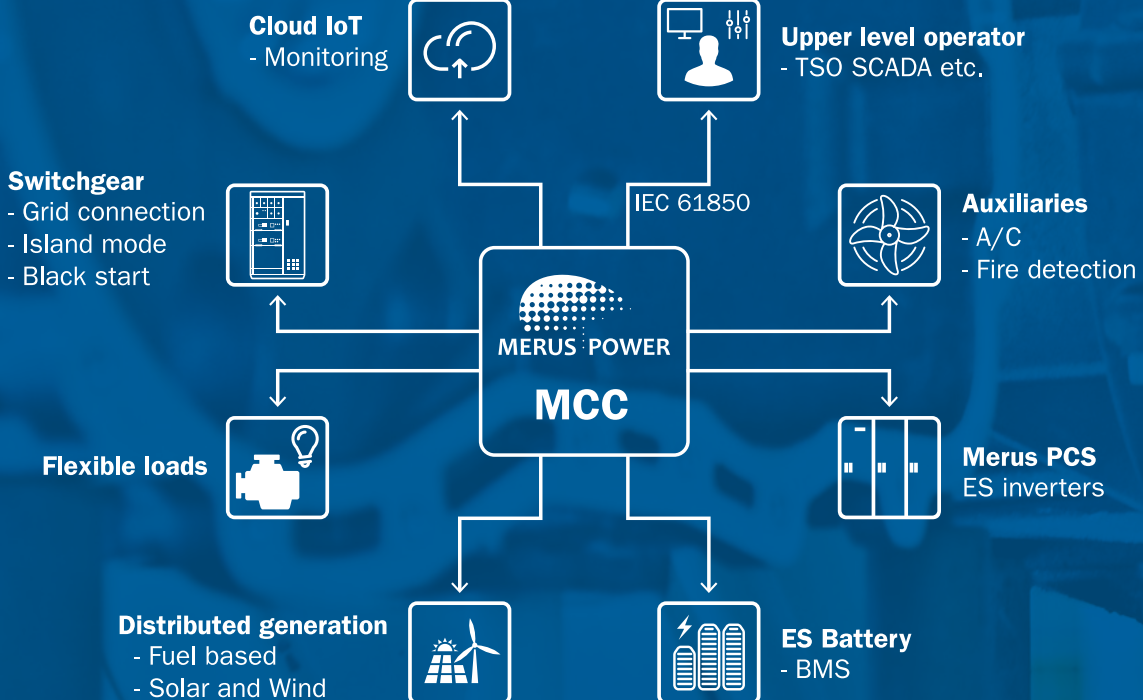
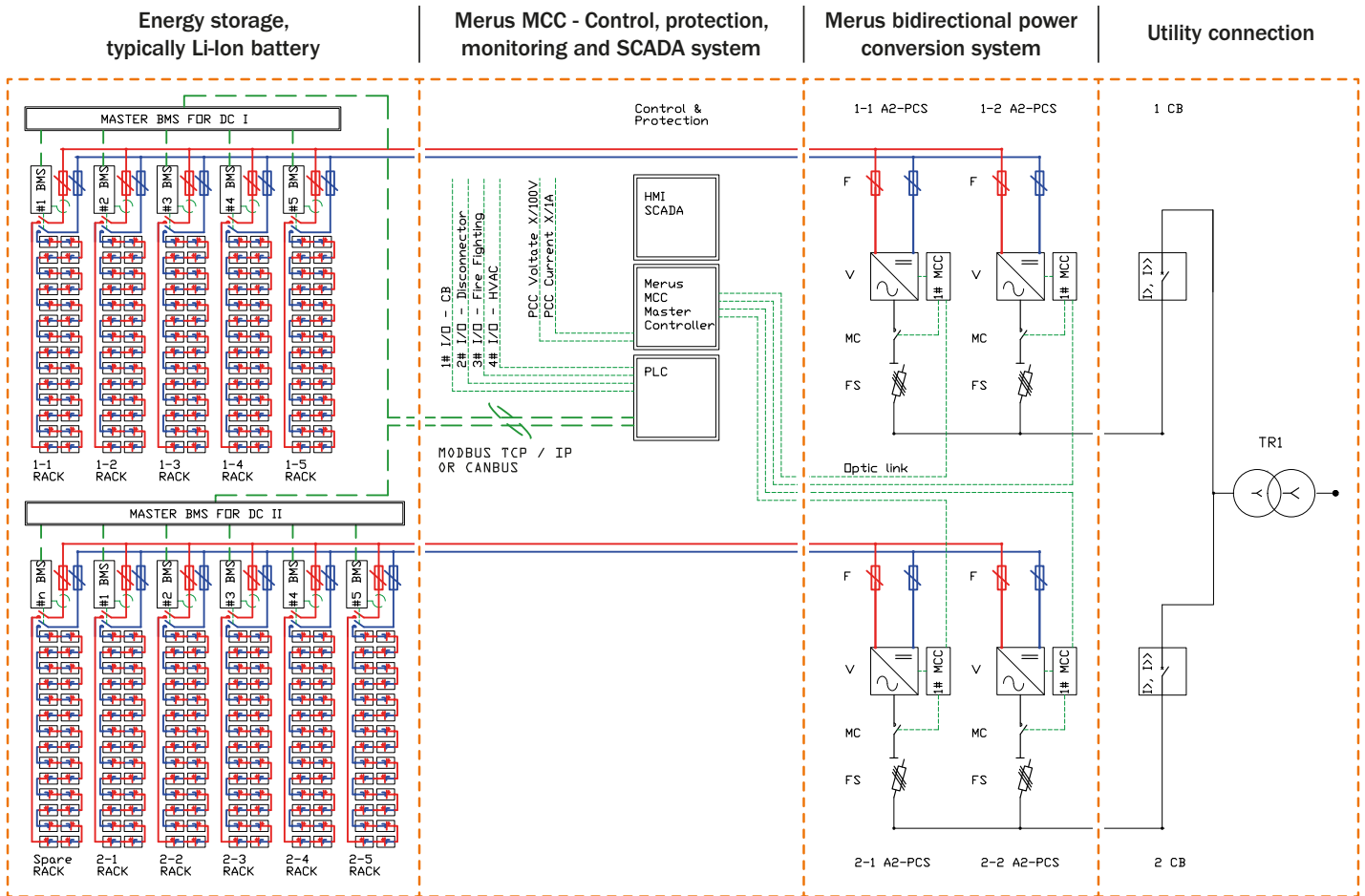

Merus Power Conversion System (PCS)

Merus bidirectional state-of-the-art converters use 3-level NPC topology to enable low loss operation, high DC voltage and the best power quality performance thanks to optimized switching frequency.

DC voltage is available with a wide range spanning 600 - 4000Vdc. Bidirectional modules in various sizes are available starting from 50kVA up to 2000kVA, enabling the most cost-efficient solution for each customer-specific project up to hundreds of MWh, or even larger scales.

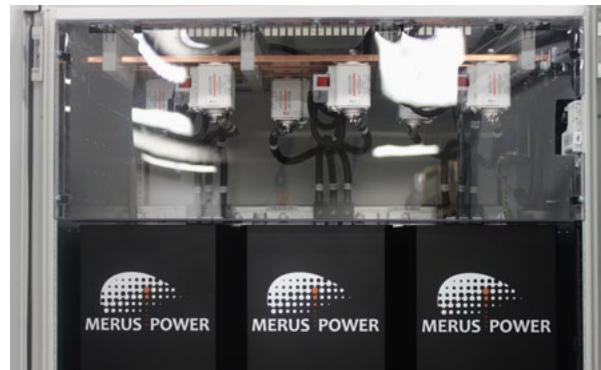

Battery energy storage

The battery energy system consists of battery modules connected in series to meet the required direct voltage level, typically 600-1500Vdc. The racks are connected in parallel to meet the needed energy capacity. One group of series-connected battery modules form the storage rack. Each rack can have its own battery management system (rack BMS) to manage the state of charge (SOC), state of health (SOH), voltage, current and temperature of each level of battery modules in the rack, as well as the control and protection.



Merus MCC controller for any applications

Merus MCC controller measures system voltages and currents and calculates the required PCS current based on measurements, active operation modes and battery status. It transmits reference current to PCS modules via a fiber optic link enabling real time ESS output control. Merus MCC controller uses modern compatible communication systems to send and receive status and operation mode settings with higher level operators such as a transmission system operator (TSO).

Merus MCC provides energy management for alternative alternative sources including solar, wind and fossil fuel power plants. The fuel saving concept for micro grid operation optimization is provided. Merus ESS has a black start functionality, meaning it has the capability to form a standalone island mode grid, to which other power sources can be synchronized.

On-line monitoring and maintenance are available via an internet service provider.

THE MOST COMMONLY APPLIED OPERATION MODES

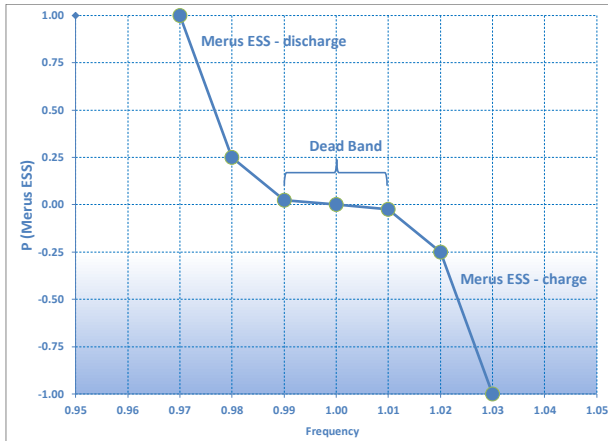

FREQUENCY REGULATION

MERUS ESS is capable of both charging and discharging, at the power level or levels, within the installed capacity or according to the preset operation mode combinations.

MERUS ESS can provide autonomous real-time frequency regulation based on the frequency measured from the Host Utility's electric system. The frequency regulation mode can be used simultaneously with any other operation mode as shown in the matrix.

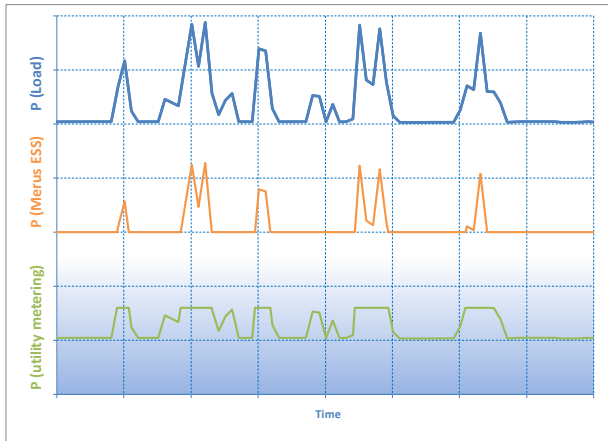

PEAK SHAVING

In the peak shaving operation mode, Merus ESS is controlled to reduce peak power demand from the Host Utility feeder to which Merus ESS is connected. Merus ESS can be discharged at any power level within its capacity.

MERUS ESS performs autonomous real-time peak shaving based on the measured active power from the Host Utility's electric system. The peak shaving mode can be used simultaneously with any other operation mode as shown in the matrix.

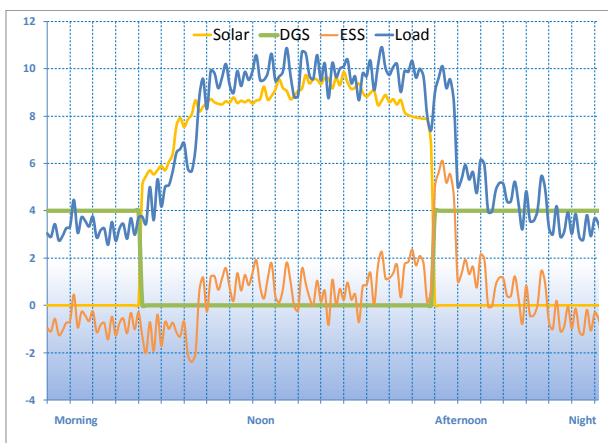

INTERMITTENT POWER RESOURCE SUPPORT – MICROGRID

Merus ESS can be used as one of the main components of a microgrid. The solution has its own microgrid controller which can operate in grid-connected and island modes. The energy management philosophy is defined by the type and capacity of the integrated power generation.

A typical microgrid may include a combination of solar and diesel power, supplemented by the ESS, as well as various types of loads. These types of microgrids are usually controlled with economic optimization in mind. I.e. The priority may then be to minimize the operation hours of the diesel power plant, resulting in savings in fuel and wear and tear costs. The aim may also be to maximize the use of low cost energy provided by a solar plant.

MERUS ESS - UPQ

ENERGY STORAGE WITH UNINTERRUPTED POWER QUALITY SUPPLY

Merus ESS-UPQ is a unique solution that combines the benefits of various power quality systems in a single robust system. Among the other ESS features, Merus ESS – UPQ protects your grid against power interruptions, voltage sags and swells caused by upstream public grid.

Merus ESS-UPQ can seamlessly decouple the microgrid from grid-connected operation to islanded operation in case of a fault and reconnect to the grid automatically when the fault is cleared. Merus ESS-UPQ ensures the power quality in the microgrid in either operation mode.

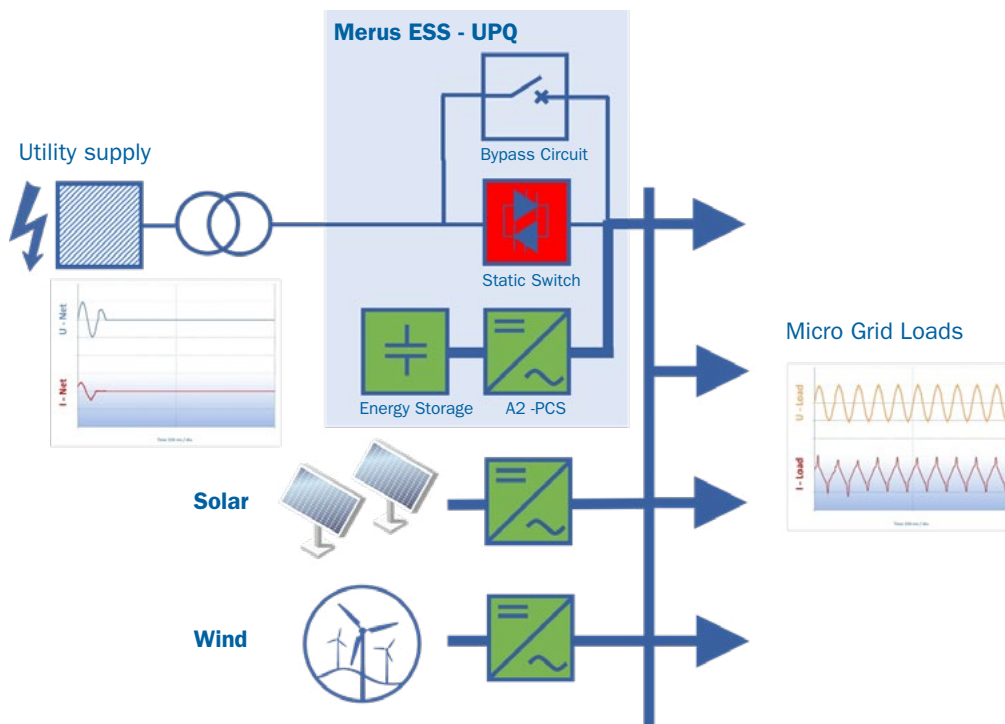

TURNKEY SOLUTION WITH RELIABLE AFTER-SALES SUPPORT

Problem Identification

Feasibility analysis

Solution Design

END TO END TURNKEY SOLUTIONS

STORAGE OPTIMIZATION

FOR SPECIFIC CUSTOMER NEEDS

Merus ESS can be tailored to meet customer needs by choosing the storage type based on the intended usage. For example, peak shaving may occasionally require high power, whereas intermitted power resource support may require small power for a long

period of time. If both operation modes are required in the same ESS, system design must be flexible. Merus ESS can be tailored to meet specific needs and designed with different energy storage media.

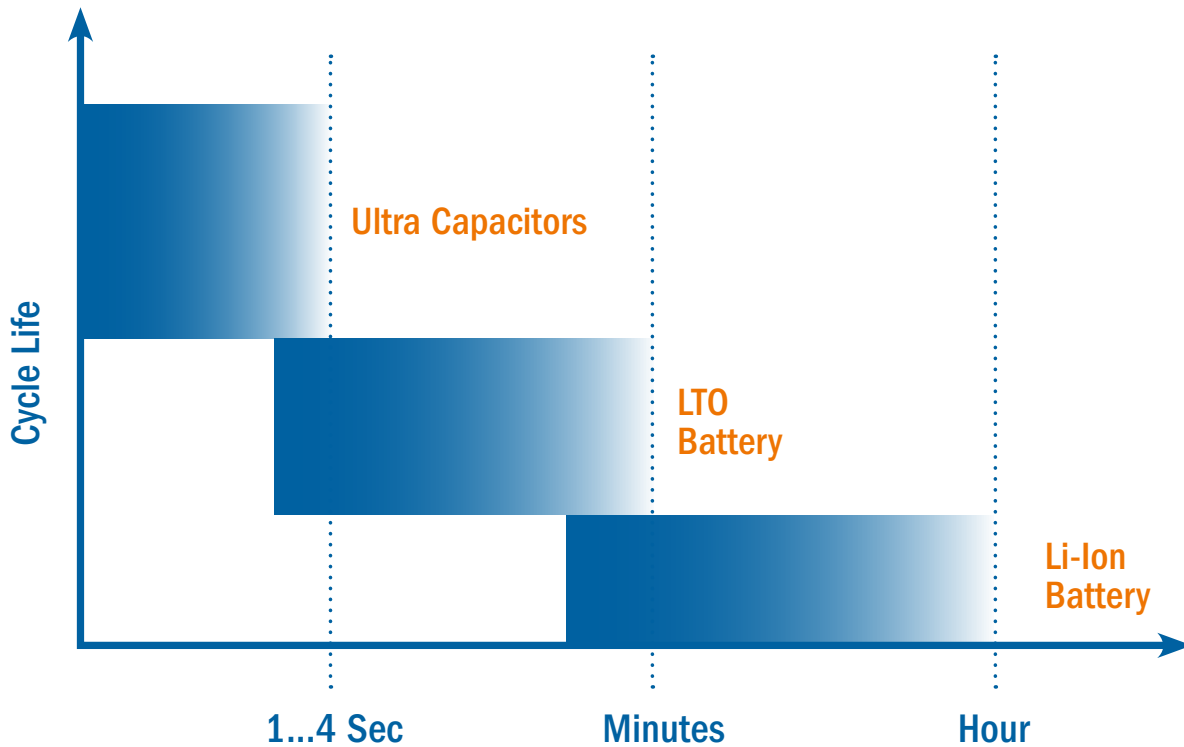

The Merus Power Solutions Team has a vast experience and sound technical capabilities to provide you with a turnkey solution. Our solutions team takes over the turnkey projects from the problem recognition phase. The scope of our supply can also include commissioning and training of the client's personnel.

Our customers require dependable after-sales support. Our after-sales support team strives to provide fastest response to the client's needs in order to keep their processes running.

Installation

Commissioning

Training

MERUS ESS TURNKEY SOLUTIONS

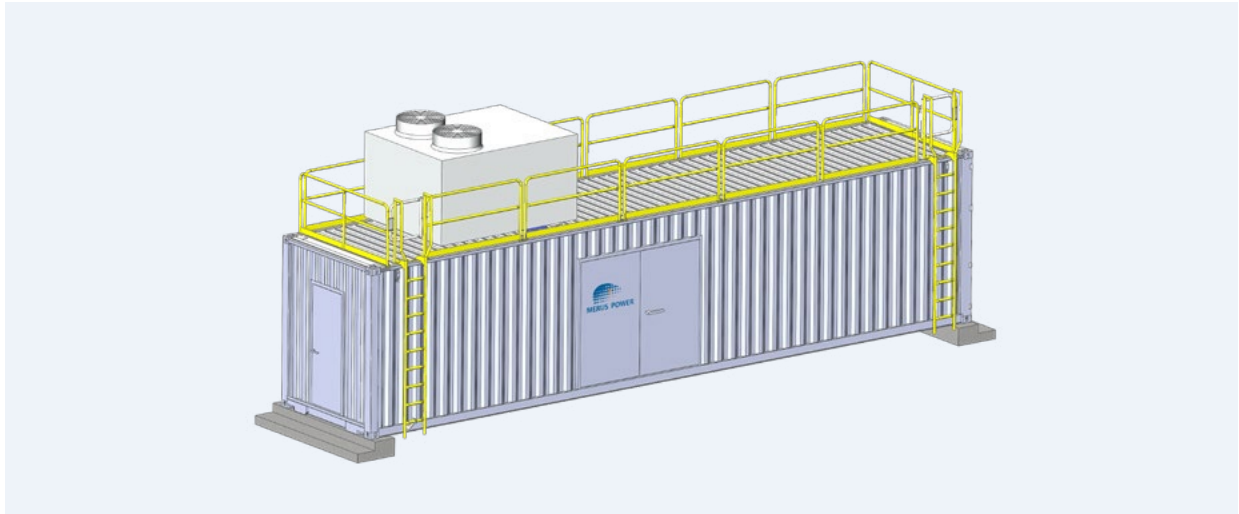

Merus ESS – type 1: Storage, PCS and transformer integrated in container



Merus ESS – type 2: Storage and PCS integrated in container. Outdoor power transformer for utility

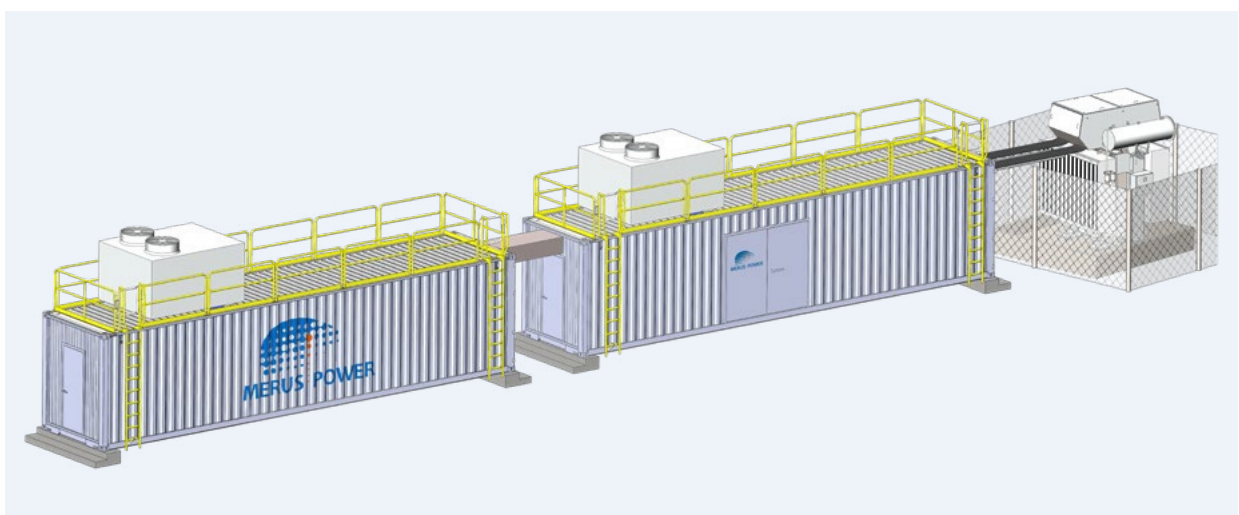

Merus ESS – type 3: Storage and PCS integrated in separate containers. Outdoor power transformer for utility.

Technical specifications

Main data	Type 1	Type 2	Type 3
Nominal system voltage up to UN	22000 V	HV	HV
Nominal system frequency fN	50 / 60 Hz		
Installed Energy E (BoL)	1540 kWh	2200 kWh	4180 kWh
Installed Power (BoL)	3080 kW	4400 kW	8360 kW
Mechanical installation (Pre fabricated containerized solution)			
Container dimensions (Width x Depth x Height mm)	12200 x 2450 x 4100	12200 x 2450 x 4100	12200 x 2450 x 4100 (Storage) 6100 x 2450 x 4100 (Inverters)
Total weight in kg	28000	30000	41000 (Storage) 13000 (Inverter)
Cabinet Protection Degree	IP 54 to EN 60529		
Site condition -Typical			
Ambient temperature	-40/+45 C°		
Altitude	≤ 1000 m.a.s.l		
Pollution	Pollution Degree 2: Normally only nonconductive pollution occurs. Temporary conductivity caused by condensation is to be expected.		
Max wind	34 ms / s		
MCC - Control System - hardware and software			
Controller	Real time digital controller		
Processor module for master control	High performance DSP / FPGA board		
Processor for floating point calculations	Texas Instruments C6713 floating point DSP 8 x 300MHz		
Communication	Standard fibre optics communication cards with Avago Versatile link		
Control system for external I/O operations	Siemens S7-1500-series PLC CPU (integrated)		
MCC - Control System - Protection system			
IGBT Power Stack protection	MCC		
Battery protection	BMS		
MCC - Control System - Human-machine interface (HMI - SCADA)			
HMI type	High quality industrial type touch screen PC with Hot Swap RAID SSD		
HMI languages	Finnish - English - German - Spanish - Chinese - Russian. Others on request.		
Monitoring and Reporting	Monitoring and reporting data upto 1 month		
Communication	Ethernet, ModBus and ProfiNet (TCP/IP), IEC 61850		
Remote operations	Remote operations for monitoring and control		
Merus A2 -PCS modules			
Nominal voltage	400 - 690V		
Operating modes	All power quality operation modes		
Response time	< 100 microseconds / 1 cycle (selective mode)		
Switching frequency	20kHz		
Controller	Real time digital control with FFT		
Load balancing capacity	100% * IN		
Energy storage - battery			
Module type	Li - Ion		
Life expectation	10 years		
DC Voltage Range of rack (Vdc)	588 - 1500 Vdc		
Nominal DC capacity of rack (kWh)	110 kWh		
Max DC power of rack (kW)	220 kW (=2CP)		
Total number of racks	14	20	38

WINNING BUSINESS WITH POWER QUALITY

Merus Power offers world-leading clean technology to improve power quality, energy efficiency and environmental performance. Our dynamic compensation solutions- active harmonic filters, UPQs, energy storage systems, STATCOMs and SVCs – solve your power quality problems in no time. You will enjoy a swift payback on your investment: our solutions save energy, increase productivity and lifetime of the facility.

We also offer a service portfolio which spans the whole product lifecycle from power quality surveys to after-sales services. We provide our clients with world-class products, reliable Finnish technology, dependable and flexible service and true co-operation.

*Merus Power is a member of
Cleantech Finland.*

Merus Power Dynamics Oy
Pirkkalaistie 1, FI-37100, Nokia, Finland
tel: +358 20 7354320
fax: +358-3-2255344
email: sales@meruspower.fi
www.meruspower.fi
2018.ESS.01

